

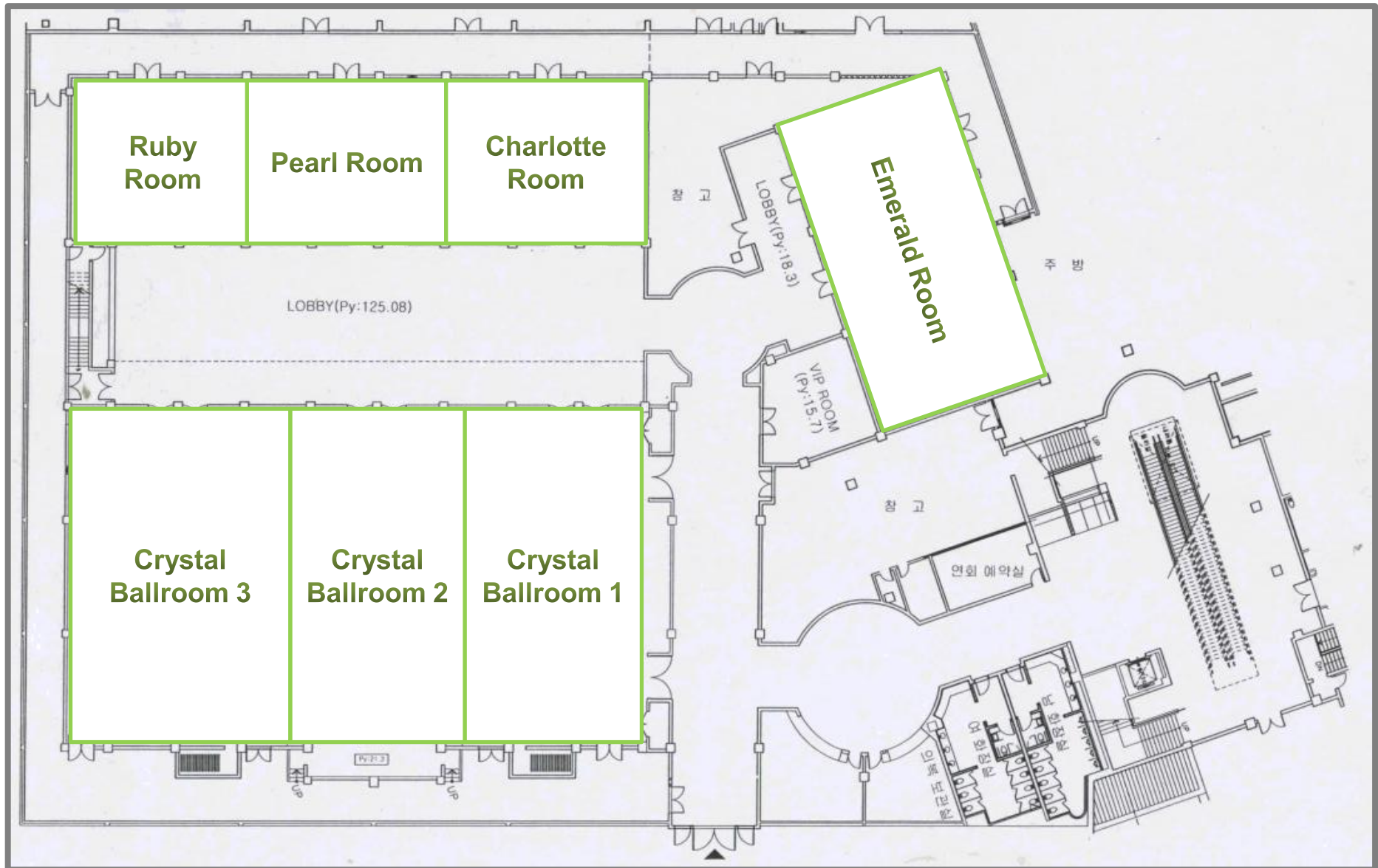

IUCN  
WORLD  
CONSERVATION  
CONGRESS  
Jeju 2012

# Conservation Campus Layout

## 1. Floor Plan in Lotte Hotel Jeju



## 2. Crystal Ballroom - 1

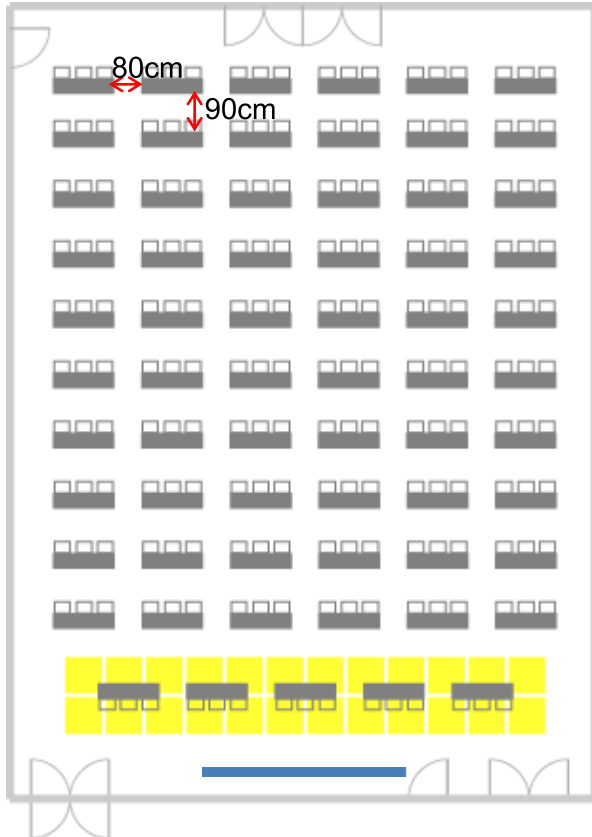
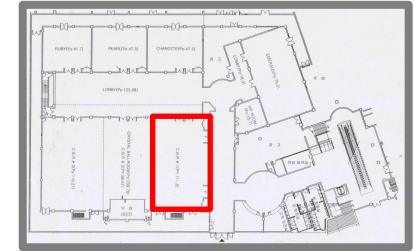

• Class Type: 180 seats

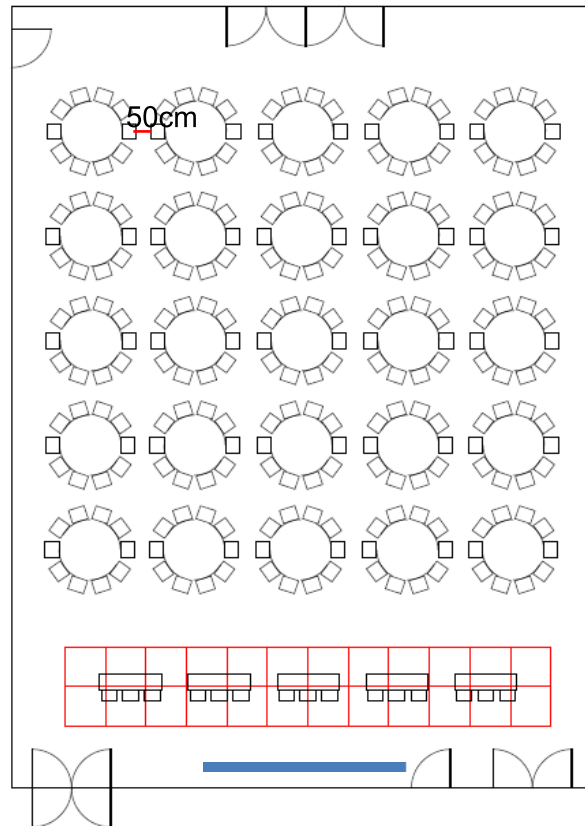

• Banquet Type: 180 seats

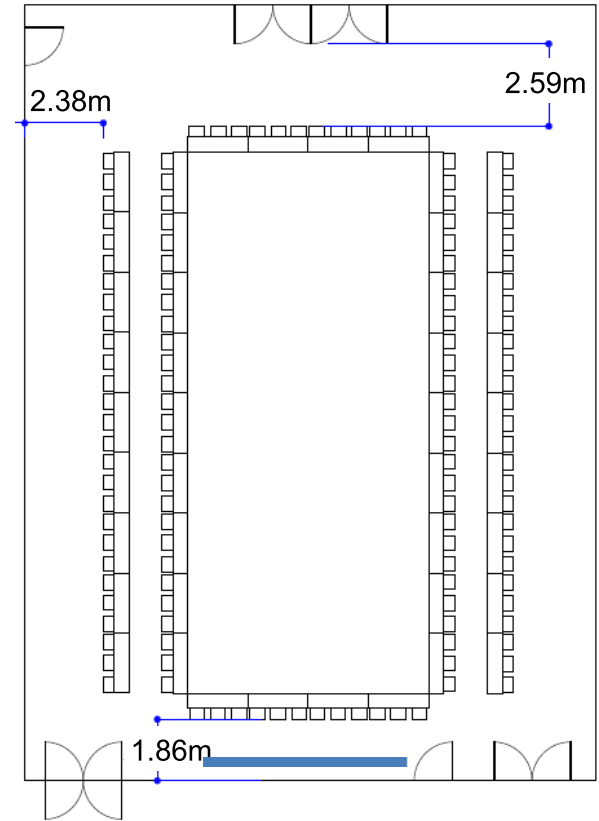

• Board Type: 132 seats

## 3. Crystal Ballroom - 2



• Class Type: 90 seats

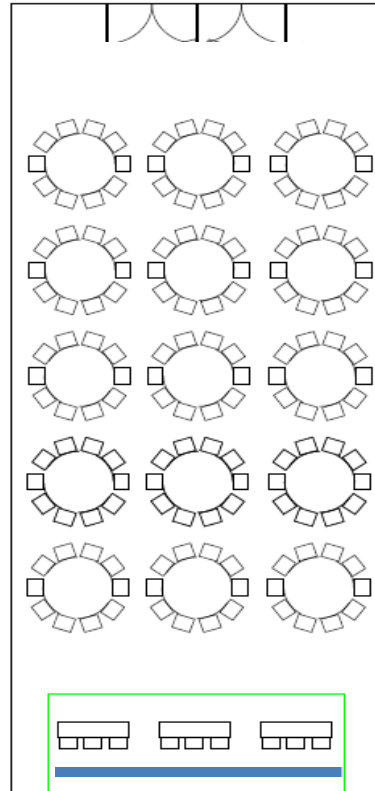

• Banquet Type: 150 seats

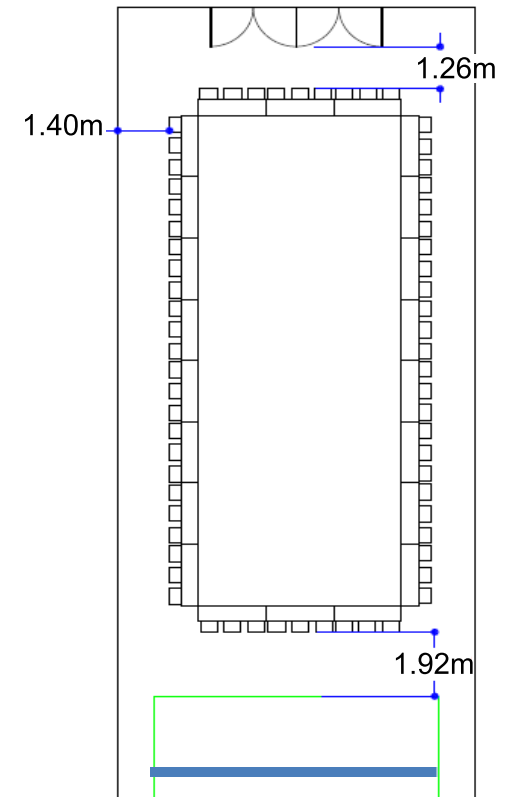

• Board Type: 66 seats

## 4. Crystal Ballroom - 3

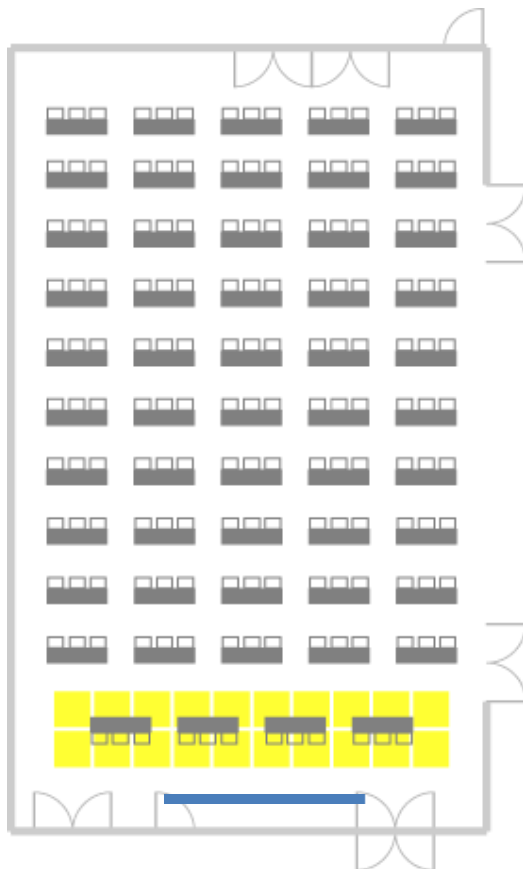

• Class Type: 150 seats

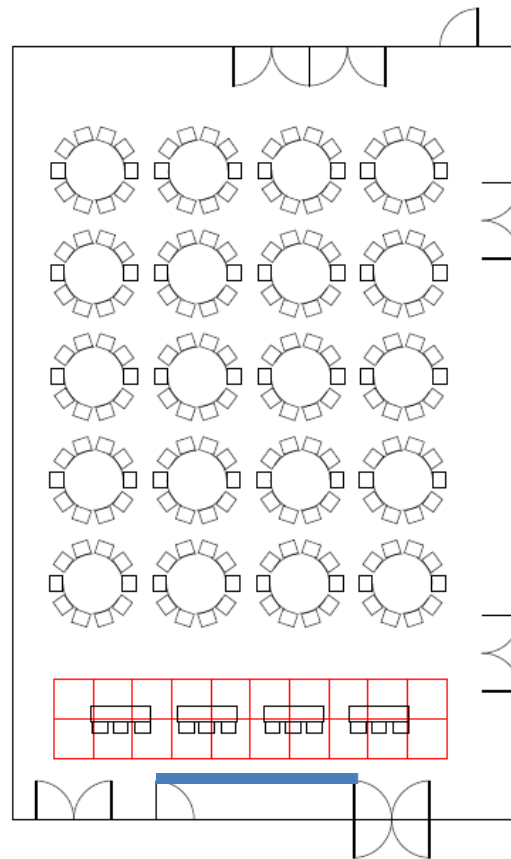

• Banquet Type: 200 seats

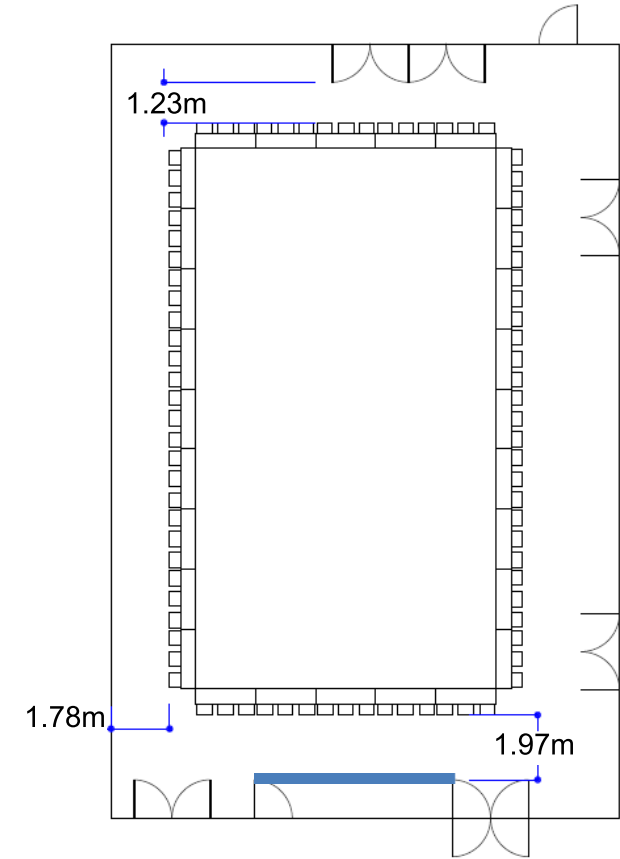

• Board Type: 84 seats

## 5. Ruby Room

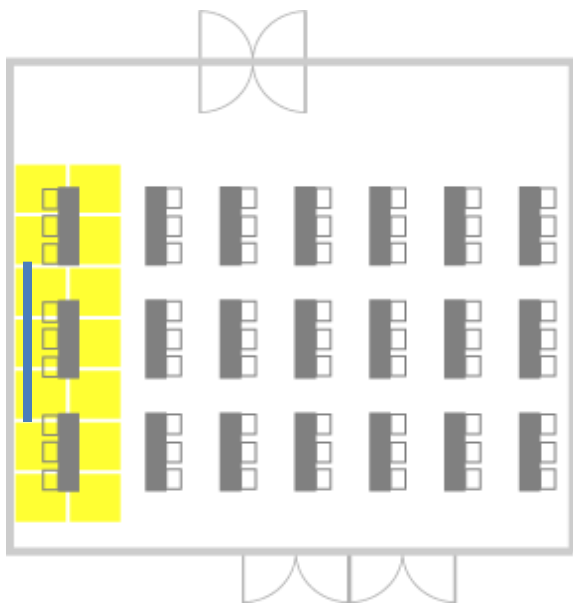

• Class Type: 54 seats

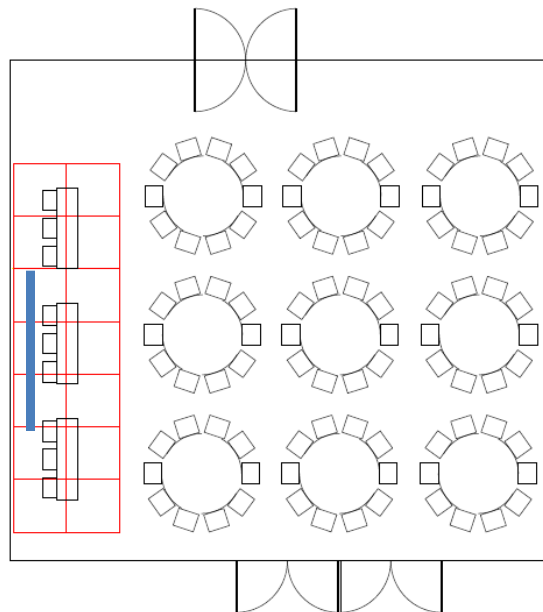

• Banquet Type: 90 seats

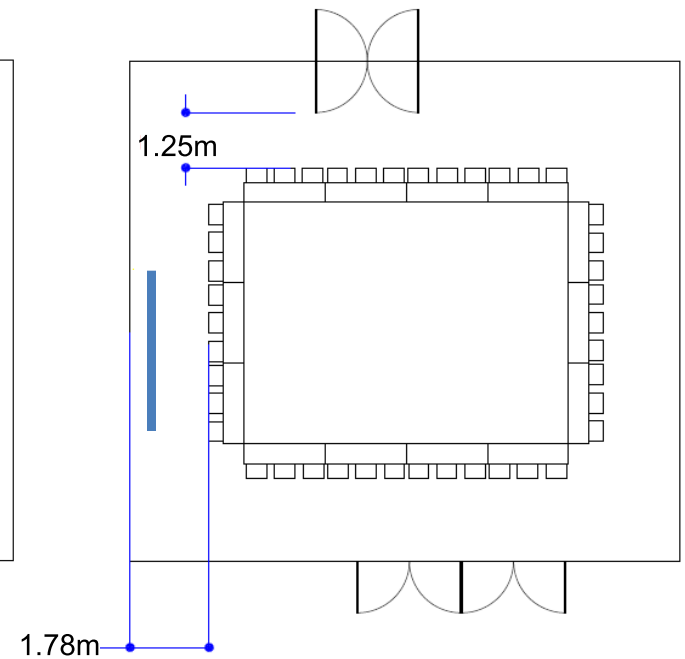

• Board Type: 42 seats

## 6. Pearl Room

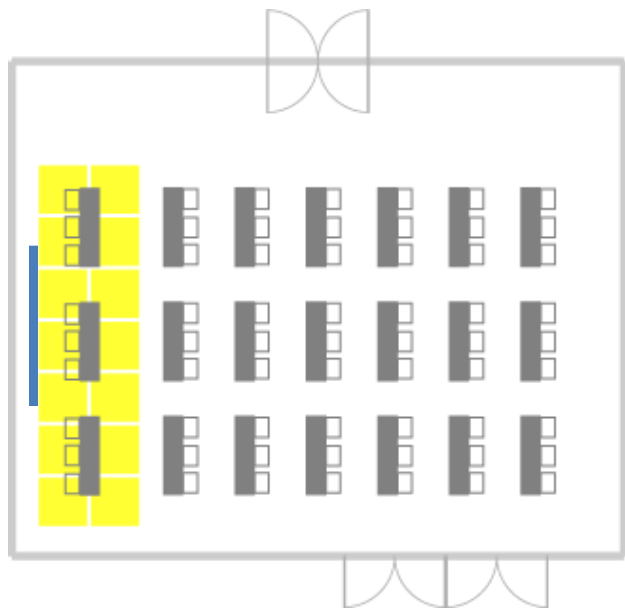
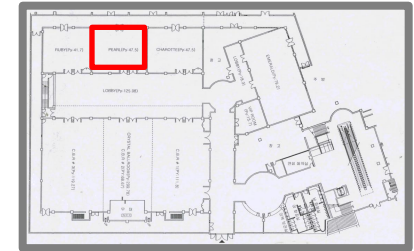

• Class Type: 54 seats

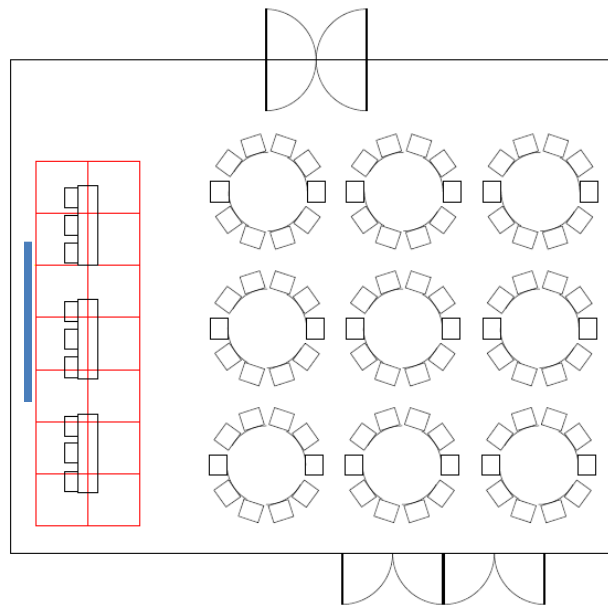

• Banquet Type: 90 seats

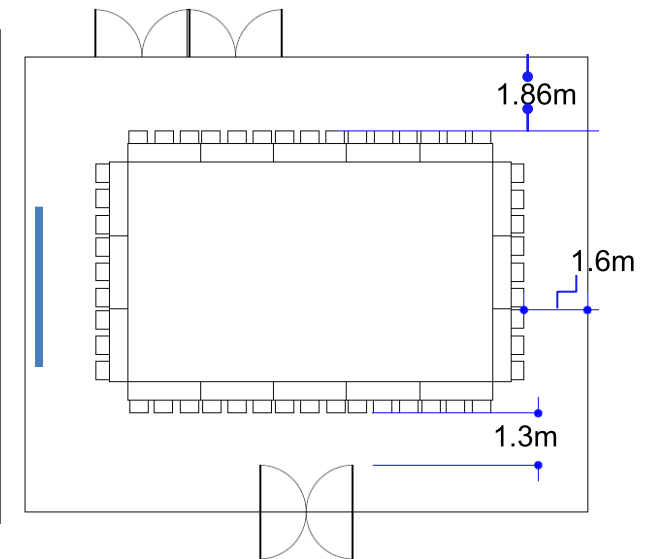

• Board Type: 48 seats

## 7. Charlotte Room

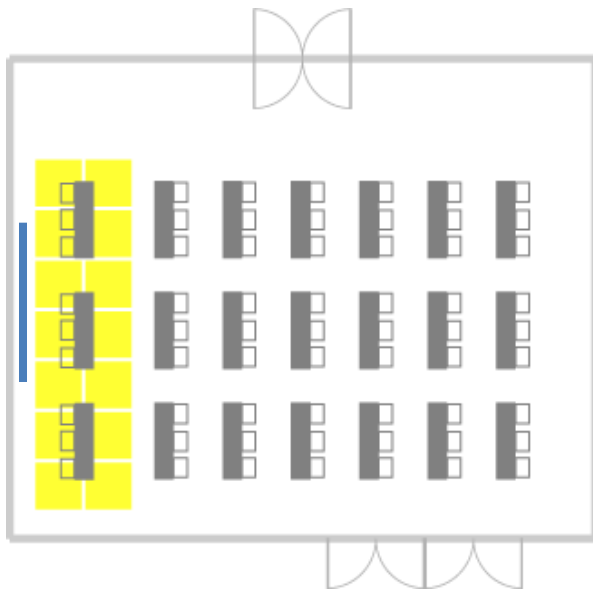
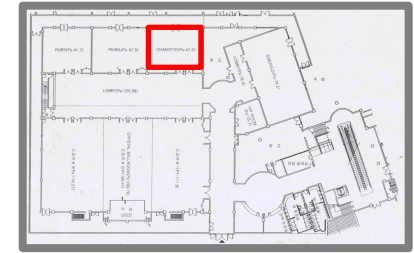

• Class Type: 54 seats

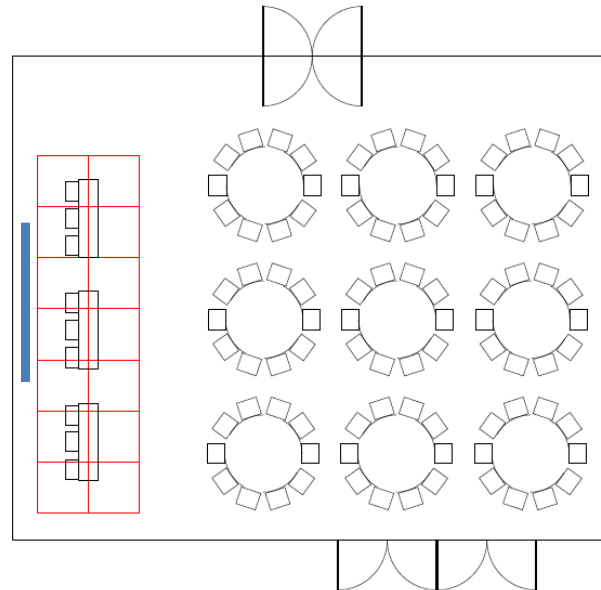

• Banquet Type: 90 seats

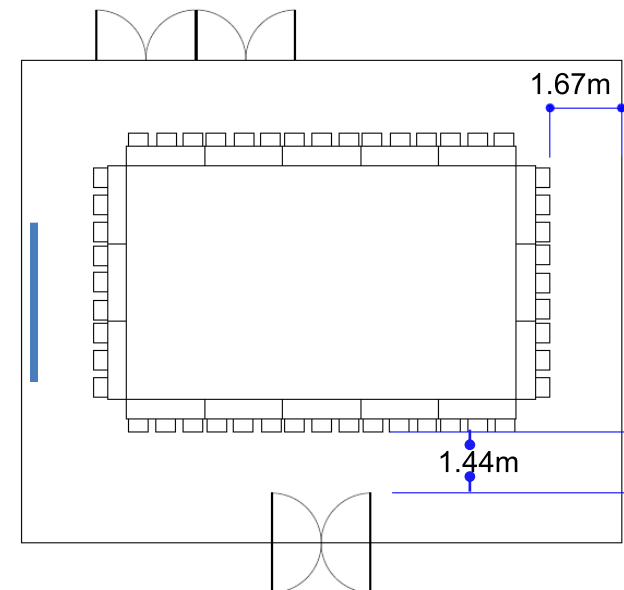

• Board Type: 48 seats



## 8. Emerald Room

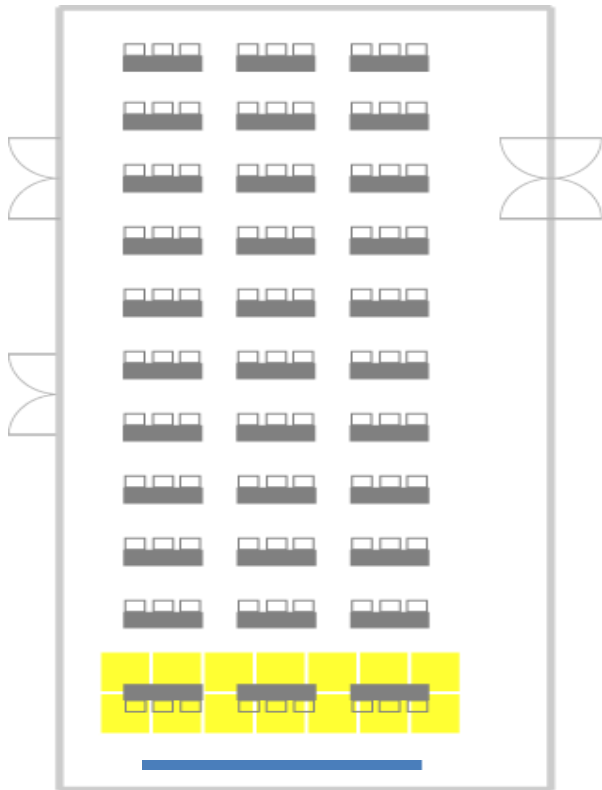

• Class Type: 90 seats

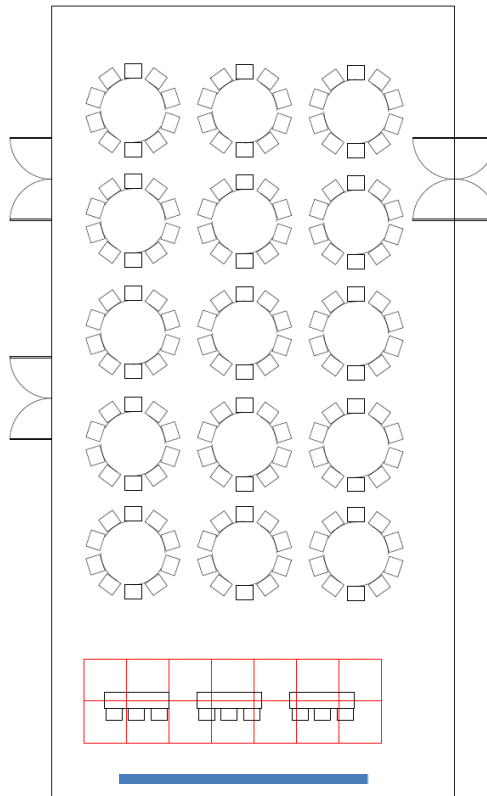

• Banquet Type: 150 seats

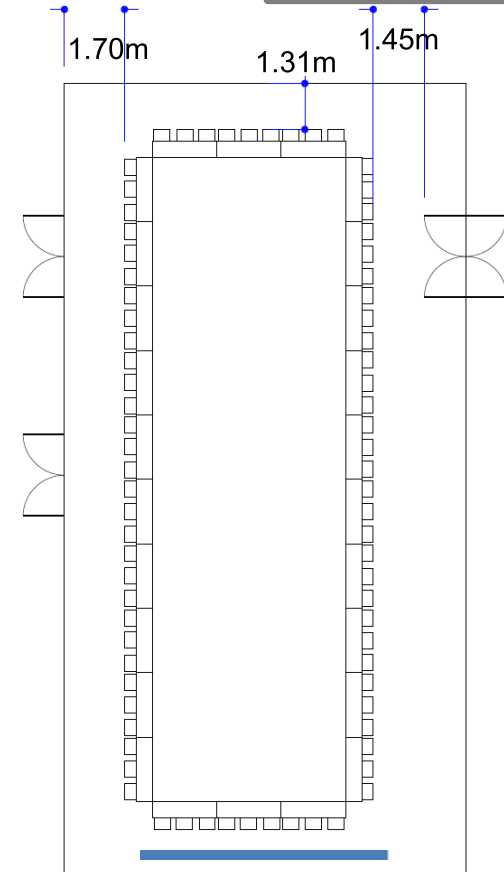

• Board Type: 78 seats

## 9. Sappier Room

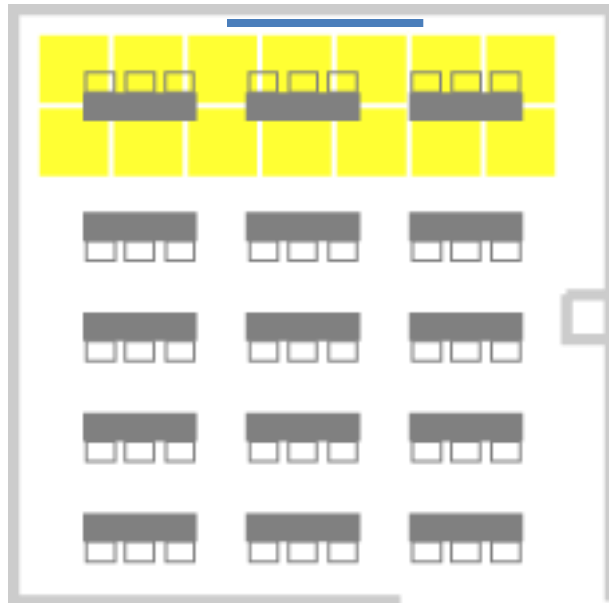

• Class Type: 36seats

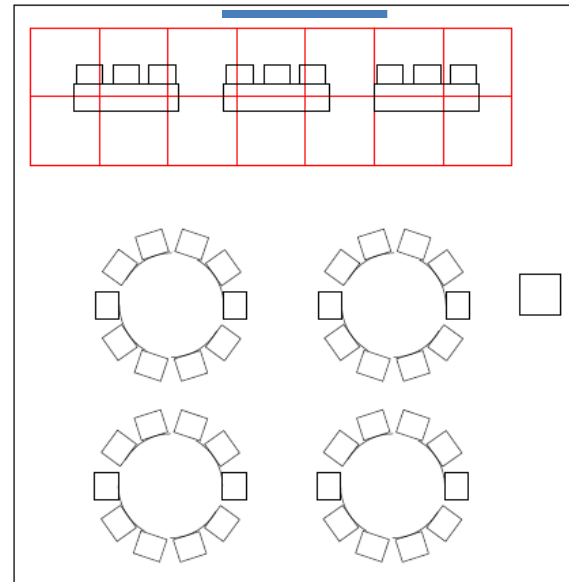

• Banquet Type: 40 seats

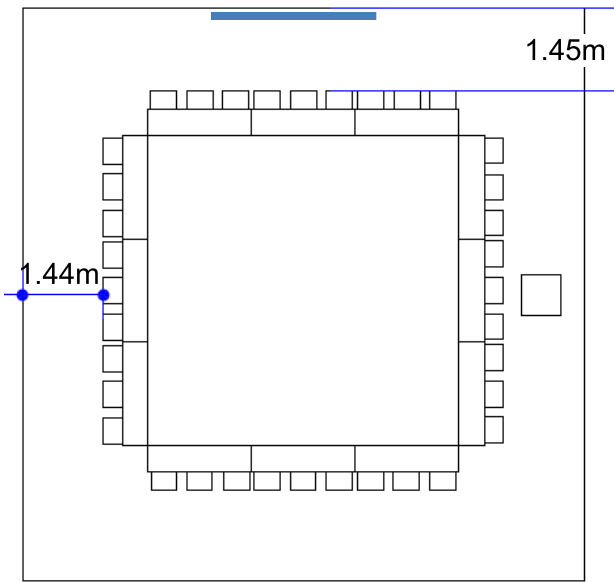

• Board Type: 36 seats